

MOTOR 3-PHASE

Worm gear motor IE1 3x230/400 V, 50 Hz

F22090091

90/91



- Adapted for variable speed control
- Aluminium coating for better thermal dissipation
- Built-in thermal contact, drawn to terminal
- Compact built-in dimensions according to IEC-standards
- Extended output shaft
- Two-year product warranty

DIMENSIONS

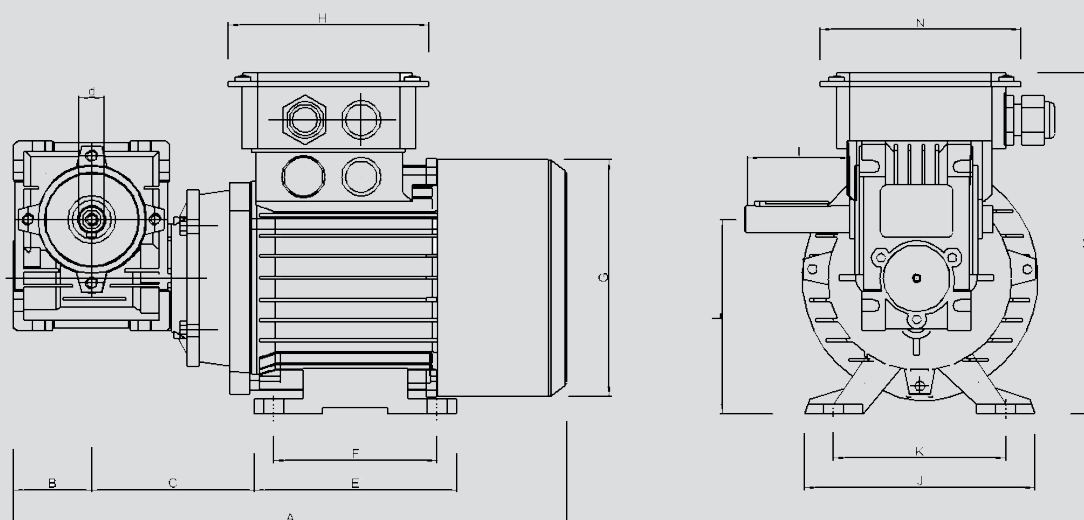

Construction dimensions (mm)

MOTOR	A	B	C	d	E	F	G	H	I	J	K	L	M	N
90/91	265	40	80	14	90	71	110	101	61	108	90	86	153	101

Technical data at 50 Hz

Motor	90/91
Efficiency class	IE1
Poles	4
Rated output	90 W
Rated current 230/400 V	0,7/0,4 A
Connection voltage	3x230/400 V
Rated speed output gear	92 rpm
Ambient temperature	-15 - +40 °C
Maximum operating temperature	<+40 °C
Rated torque output gear	5,7 Nm
Gear ratio	1:15
Protection form	IP55
Weight	3,9 kg

Max rotor diameter at rotor speed 12 rpm

Motor	90/91
Rotor diameter	1500 mm

Other data

When run with our control units, the motor must be D-connected (3 x 230 V).